

BASORFIL

Protocolos para la creación de accesorios

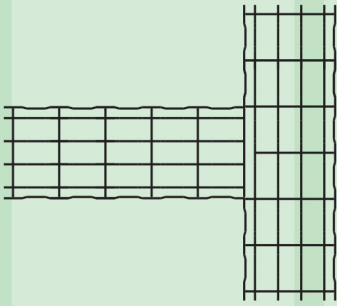

T/CROSS

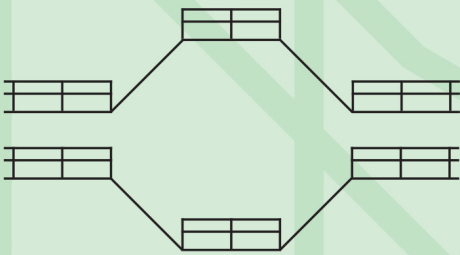

CHANGING LEVEL

COMO CORTAR

Utilizar siempre tenazas de corte asimétrico.
Cortar lo más cercano posible a la varilla tanto en horizontal como en vertical.

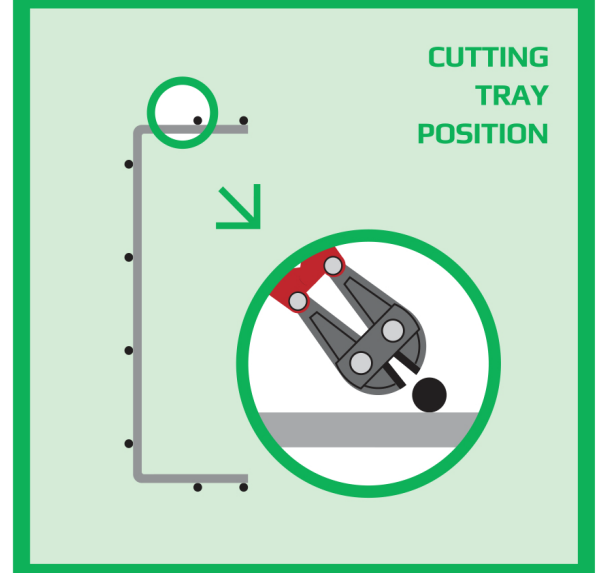
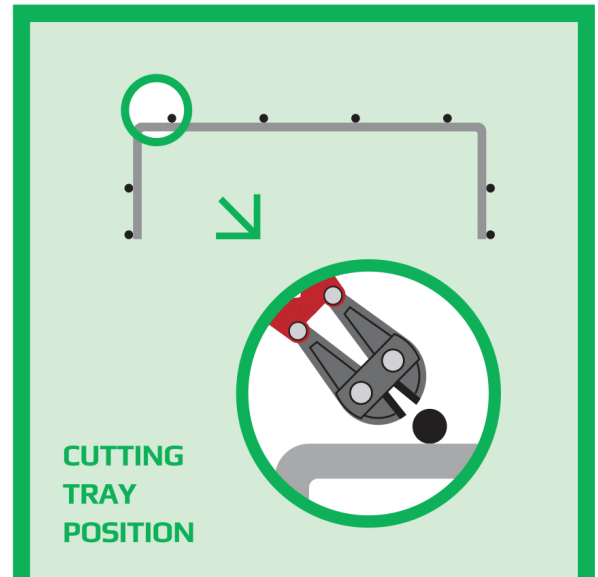
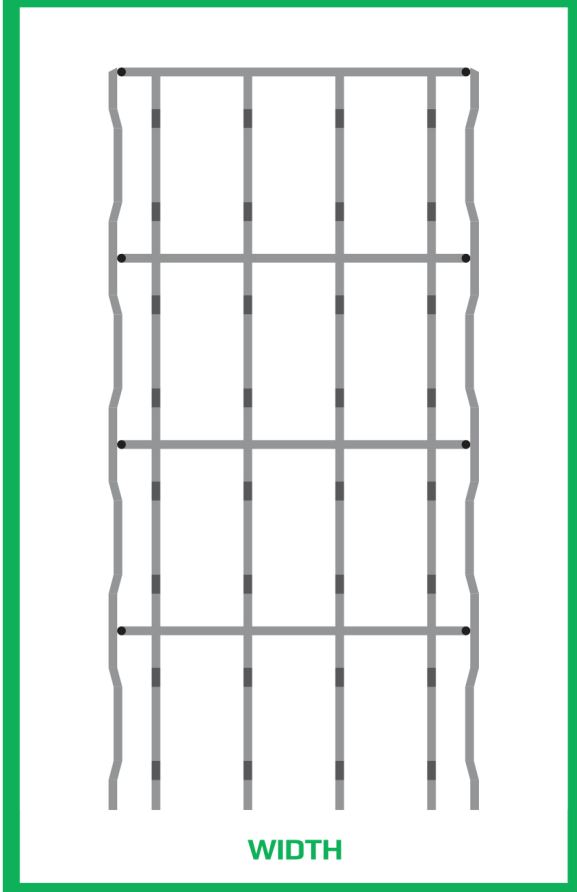
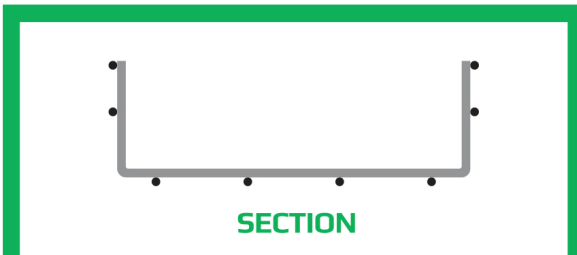
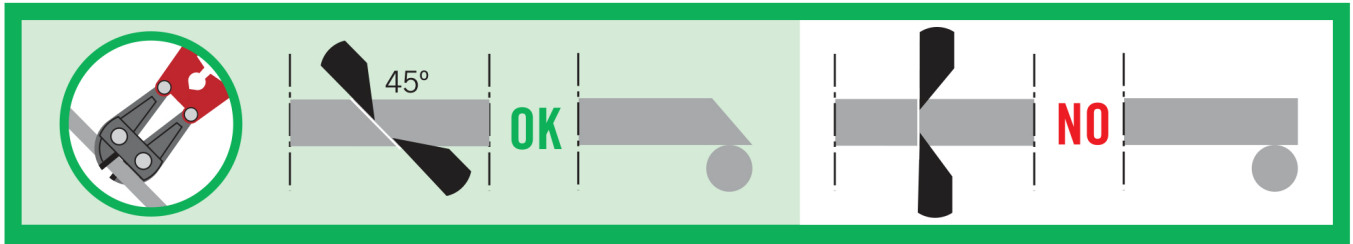
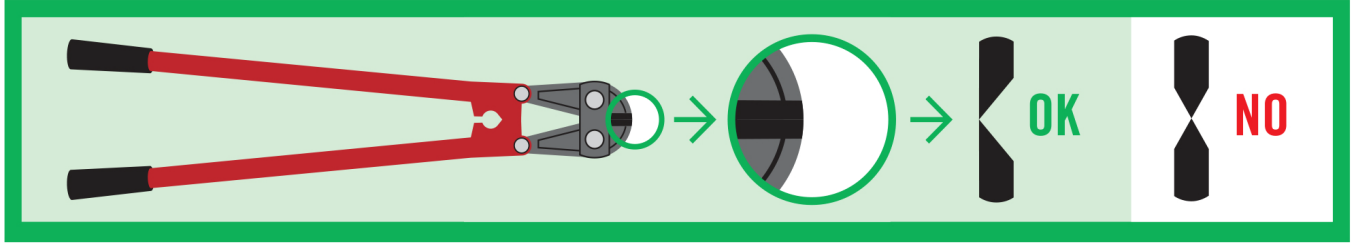

CURVA PLANA DE RADIO LARGO

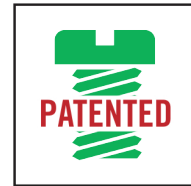
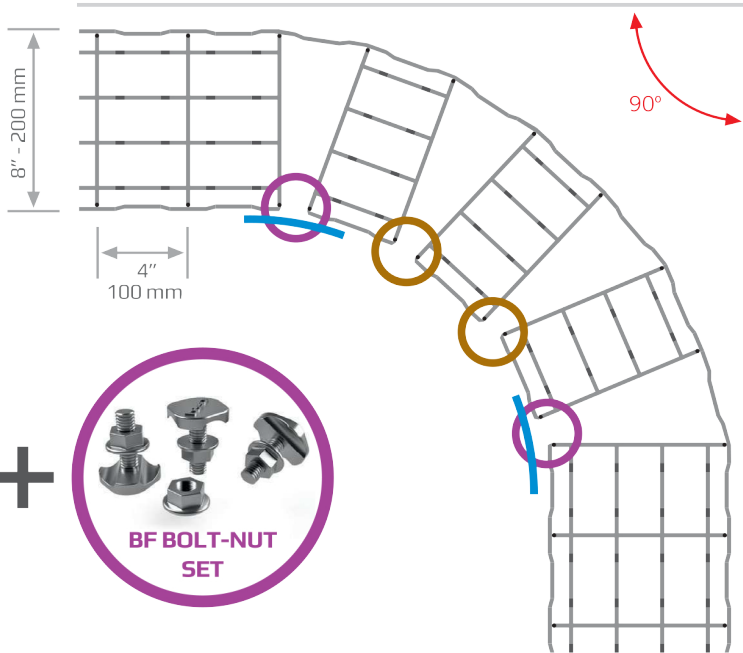
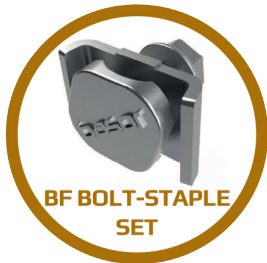

Video disponible

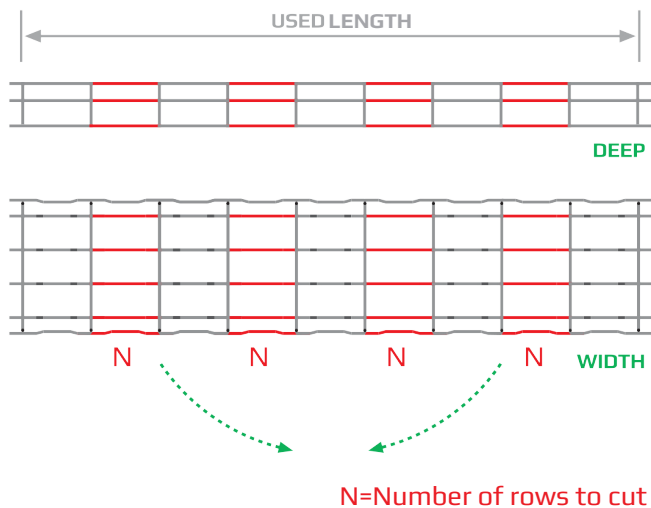
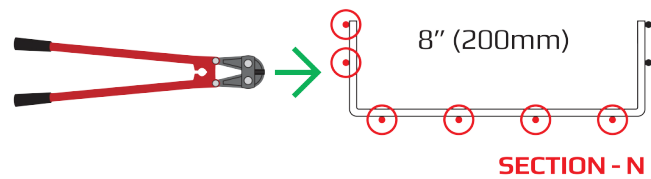

WIDTH	N	ACCESSORIES	RADIUS		USED LENGTH	
			inches	mm	inches	mm
2"	50mm	2 (2x BF Bolt-Nut Set + Multiunion joint)	-	-	5x4"	5x100
4"	100mm	3 (3x BF Bolt-Nut Set + Multiunion joint)	8'65	220	7x4"	7x100
6"	150mm	4 (4x BF Bolt-Nut Set + Multiunion joint)	11'03	280	9x4"	9x100
8"	200mm	[2x (2x BF Bolt-Nut Set + Multiunion joint) + 2x (Bolt-Staple Set)]	11'03	280	9x4"	9x100
12"	300mm	[2x (2x BF Bolt-Nut Set + Multiunion joint) + 4x (Bolt-Staple Set)]	16'92	430	13x4"	13x100
16"	400mm	[2x (2x BF Bolt-Nut Set + Multiunion joint) + 6x (Bolt-Staple Set)]	18'11	460	17x4"	17x100
20"	500mm	9x (Bolt-Staple Set)	27'56	700	19x4"	19x100
24"	600mm	11x (Bolt-Staple Set)	30'31	770	23x4"	23x100

CURVA PLANA DE RADIO LARGO AJUSTABLE

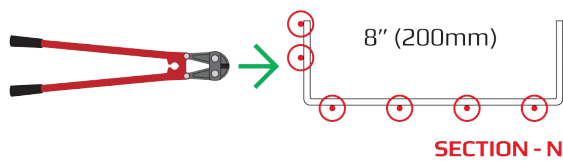
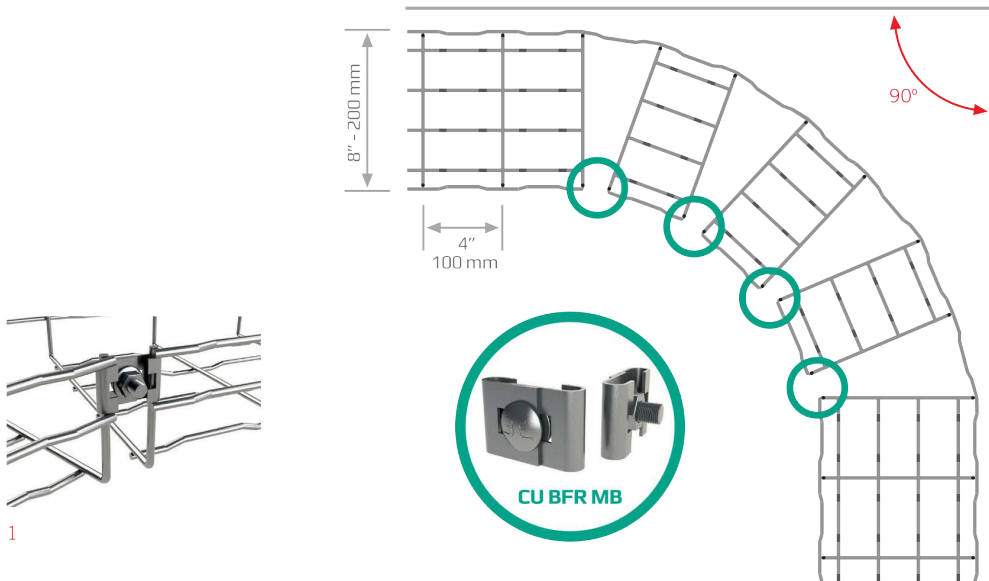

Video disponible

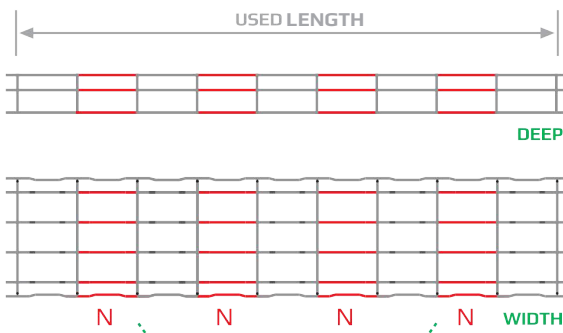

N=Number of rows to cut

WIDTH	N		RADIUS		USED LENGTH		
			inches	mm	inches	mm	
4"	100mm	2	CU BFR MB	5'51	140	5x4"	5x100
6"	150mm	3	CU BFR MB	8'65	220	7x4"	9x100
8"	200mm	4	CU BFR MB	11'81	300	9x4"	9x100
12"	300mm	6	CU BFR MB	17'72	450	13x4"	13x100
16"	400mm	8	CU BFR MB	24	610	17x4"	17x100
20"	500mm	9	CU BFR MB	29'92	760	21x4"	21x100
24"	600mm	11	CU BFR MB	35'83	910	25x4"	25x100

CURVA PLANA DE RADIO CORTO

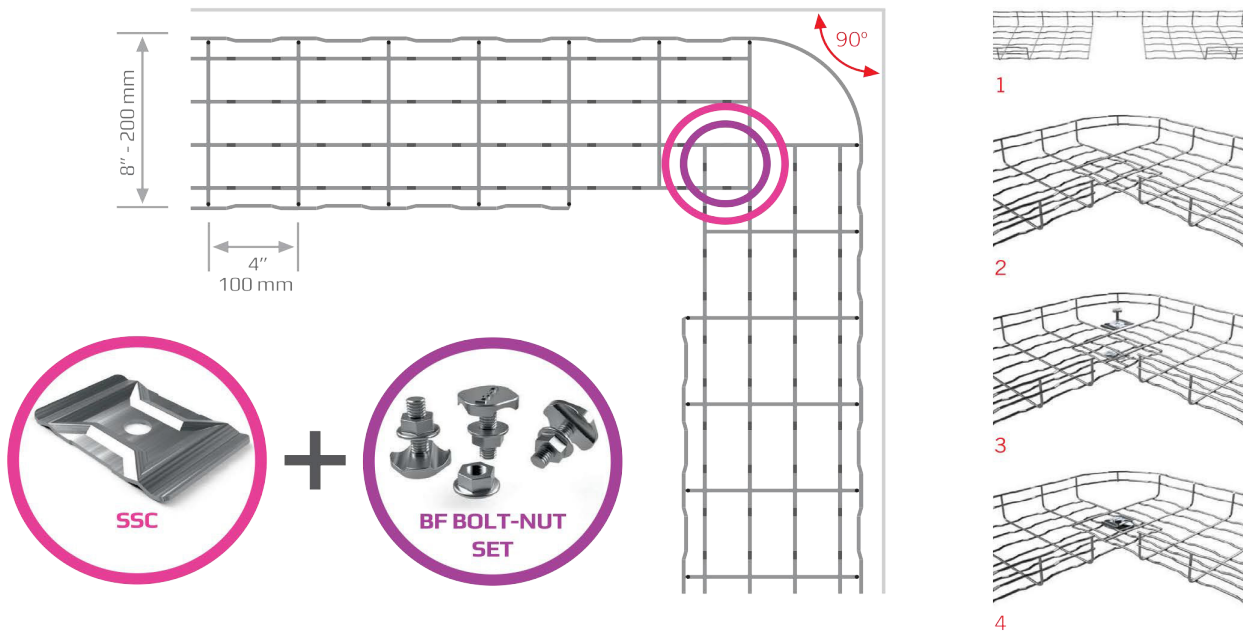

Video disponible

WIDTH	D	L	ACCESSORIES	RADIUS		USED LENGTH	
				inches	mm	inches	mm
2"	50mm	-	1	1x BF Bolt-Staple Set	-	-	3x4" 3x100
4"	100mm	1	1+1	1x BF Bolt-Staple Set	2	50	5x4" 5x100
6"	150mm	1	2+2	1x (2 SSC+BF BOLT-NUT SET)	4'72	120	7x4" 7x100
8"	200mm	2	2+2	1x (2 SSC+BF BOLT-NUT SET)	4'92	125	8x4" 8x100
12"	300mm	2	3+3	1x (2 SSC+BF BOLT-NUT SET)	4'72	120	10x4" 10x100
16"	400mm	2	4+4	1x (2 SSC+BF BOLT-NUT SET)	5'12	130	12x4" 12x100
20"	500mm	2	5+5	1x (2 SSC+BF BOLT-NUT SET)	5'12	130	14x4" 14x100
24"	600mm	2	6+6	1x (2 SSC+BF BOLT-NUT SET)	5'31	135	16x4" 16x100

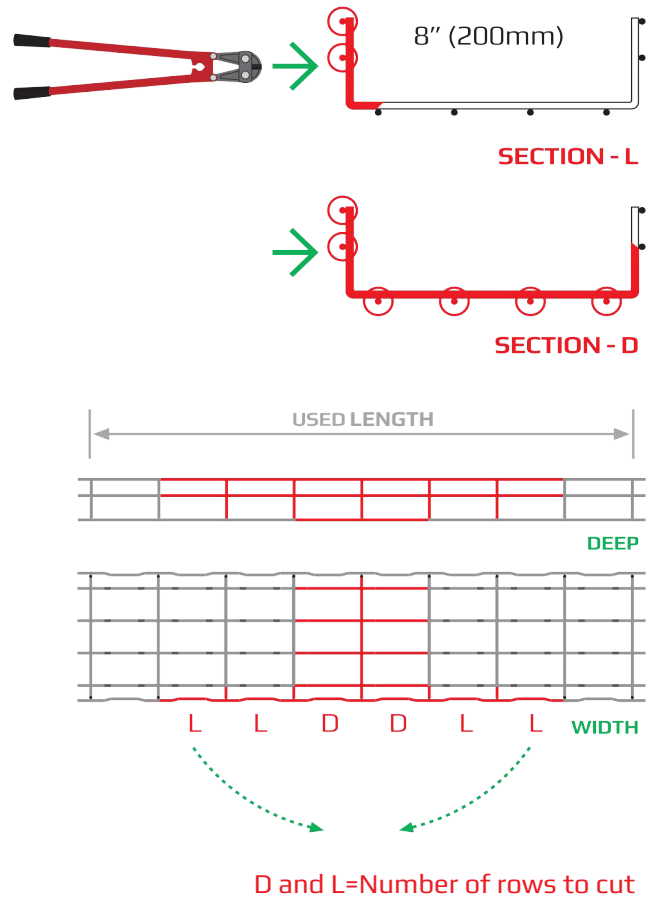

CURVA PLANA RECTA

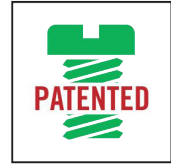
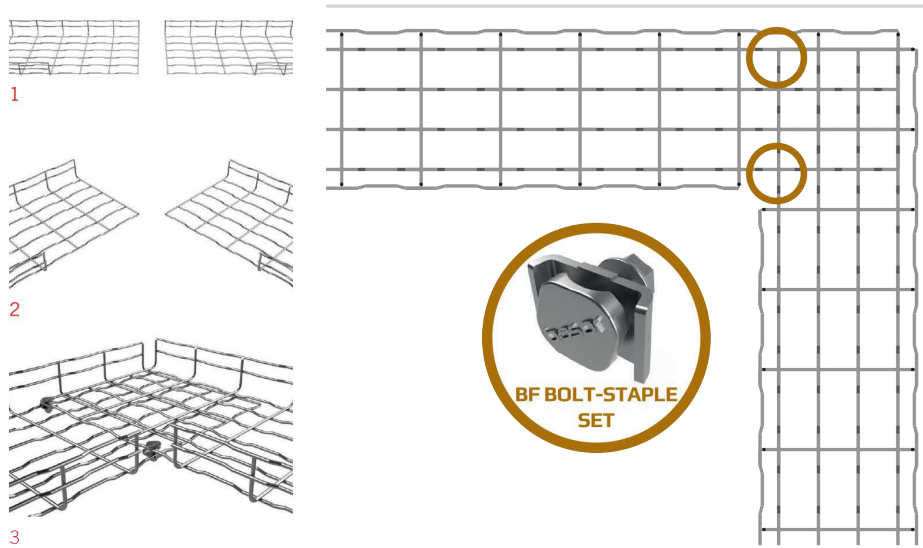

FAST BOLT NUT



Video disponible

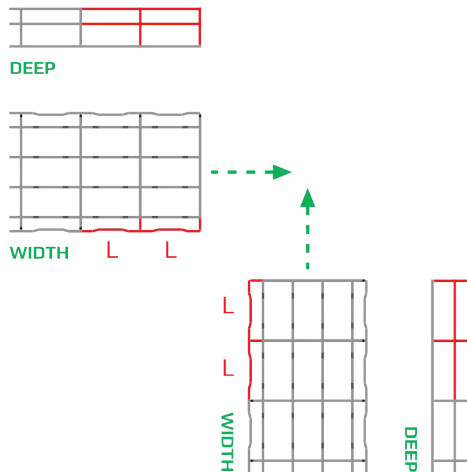
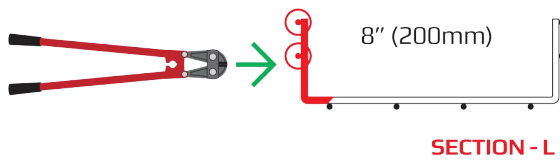

L=Number of rows to cut

WIDTH		L	ACCESSORIES
4"	100mm	1	2x BF Bolt-Staple Set
6"	150mm	2	2x BF Bolt-Staple Set
8"	200mm	2	2x BF Bolt-Staple Set
12"	300mm	3	2x BF Bolt-Staple Set
16"	400mm	4	2x BF Bolt-Staple Set
20"	500mm	5	2x BF Bolt-Staple Set
24"	600mm	6	2x BF Bolt-Staple Set

TE RECTA

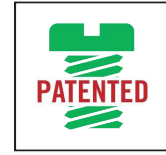
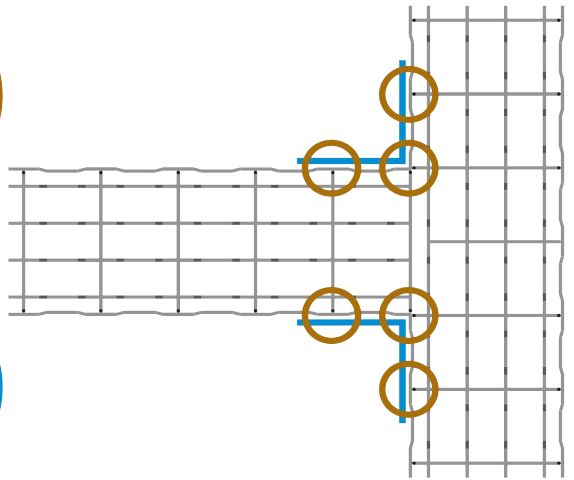
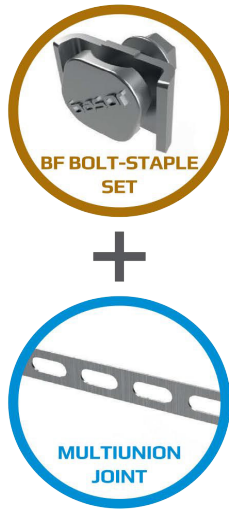

FAST BOLT NUT



Video disponible

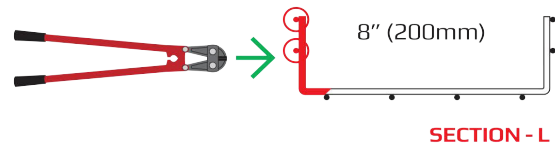

WIDTH		L	ACCESSORIES
2"	50mm	1	3x (BF Bolt-Staple Set + Multiunion joint)
4"	100mm	1	3x (BF Bolt-Staple Set + Multiunion joint)
6"	150mm	2	3x (BF Bolt-Staple Set + Multiunion joint)
8"	200mm	2	3x (BF Bolt-Staple Set + Multiunion joint)
12"	300mm	3	3x (BF Bolt-Staple Set + Multiunion joint)
16"	400mm	4	3x (BF Bolt-Staple Set + Multiunion joint)
20"	500mm	5	3x (BF Bolt-Staple Set + Multiunion joint)
24"	600mm	6	3x (BF Bolt-Staple Set + Multiunion joint)

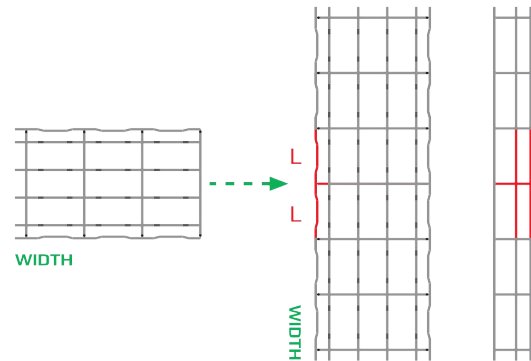

L=Number of rows to cut

TE ANCHA

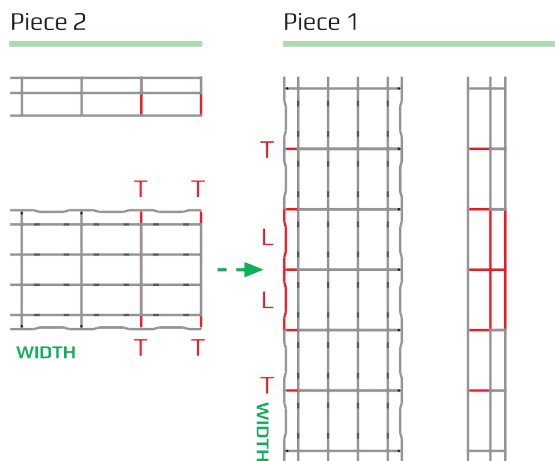
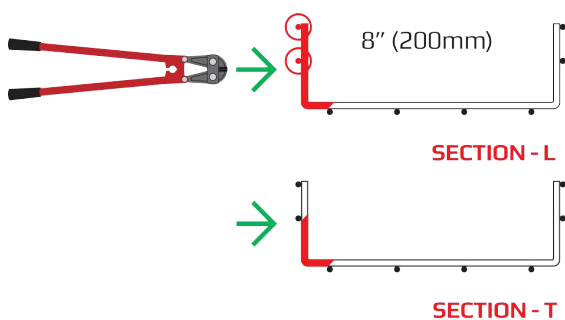
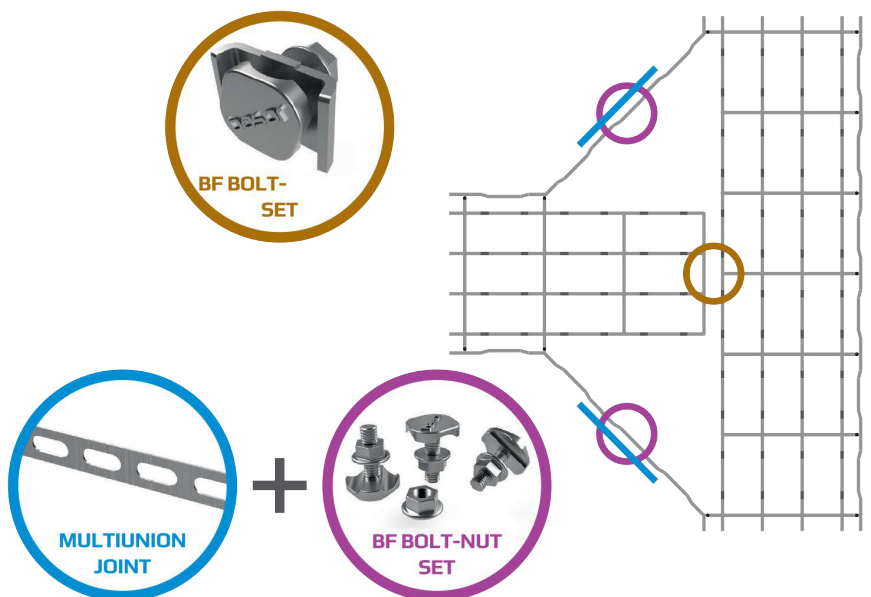

L and T=Number of rows to cut

WIDTH		Piece 1		Piece 2		ACCESSORIES
		L	T	L	T	
4"	100mm	2	1+1	1+1	1+1	3x (BF Bolt-Staple Set)
6"	150mm	3	1+1	1+1	1+1	1x (BF Bolt-Staple Set) + 2x (2x Bolt-Staple set + Multiunion Joint)
8"	200mm	3	1+1	1+1	1+1	3x (BF Bolt-Staple Set)
12"	300mm	4	1+1	1+1	1+1	4x (BF Bolt-Staple Set)
16"	400mm	5	1+1	1+1	1+1	1x (BF Bolt-Staple Set) + 2x (2x Bolt-Staple set + Multiunion Joint)
20"	500mm	6	1+1	1+1	1+1	4x (BF Bolt-Staple Set)
24"	600mm	7	1+1	1+1	1+1	4x (BF Bolt-Staple Set)

REDUCCIONES ALTURA 35 Y 65

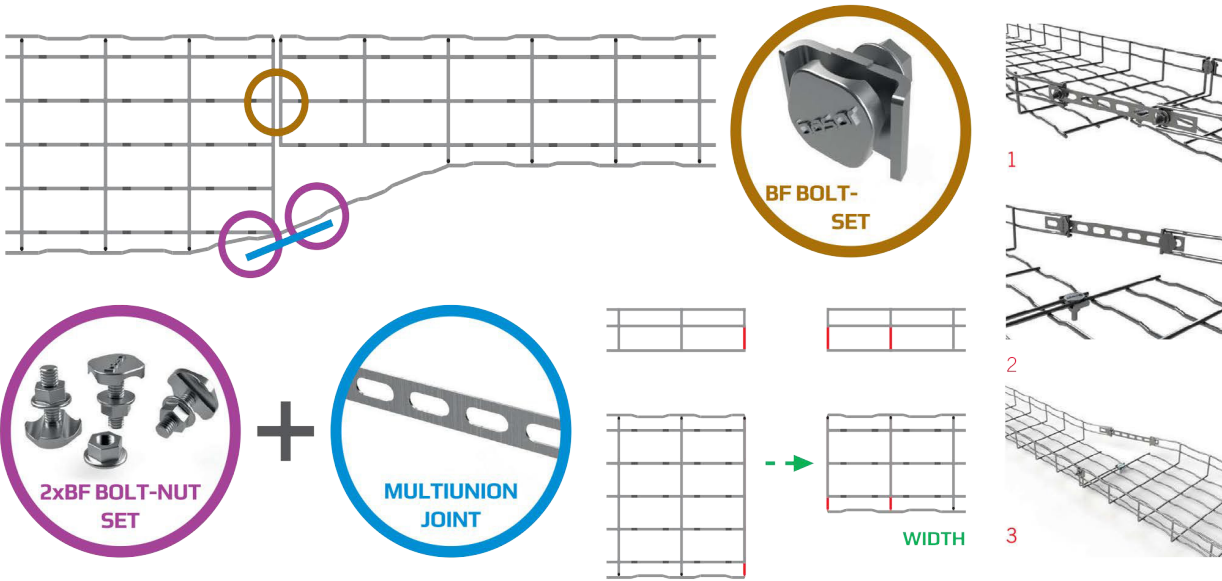

REDUCCIONES ALTURA 105

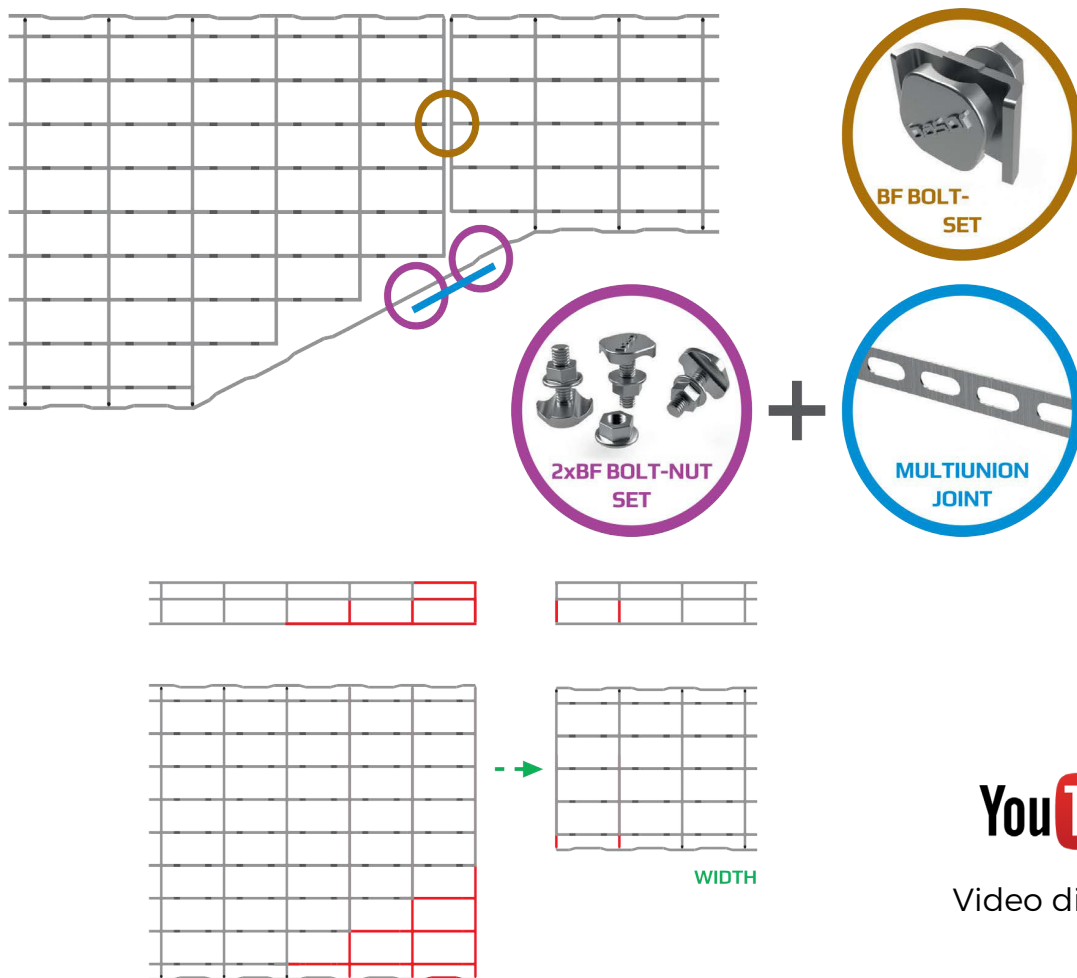

CURVAS CÓNCAVAS Y CONVEXAS

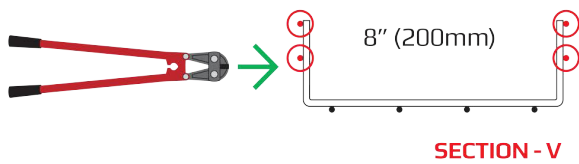
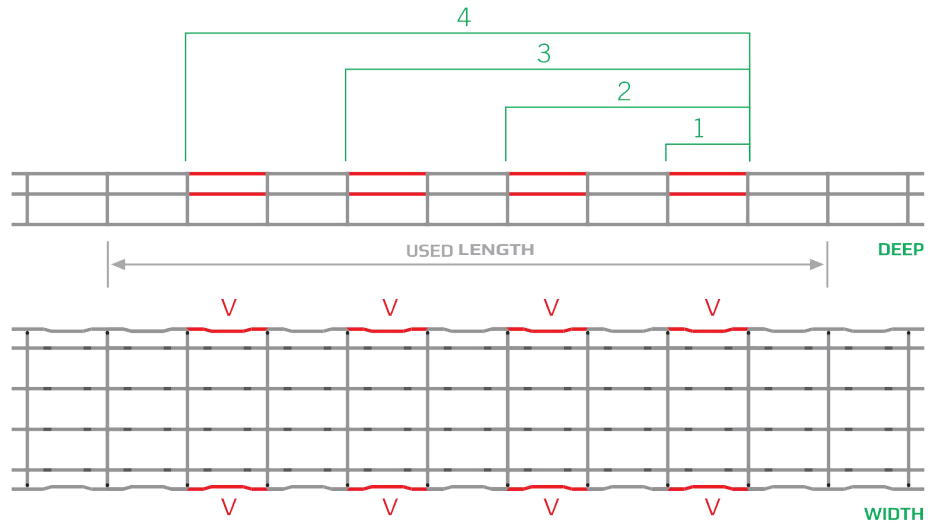

V=Number of rows to cut

RADIUS	USED LENGTH	
	inches	mm
R1	3x4"	3x100
R2	5x4"	5x100
R3	7x4"	7x100
R4	9x4"	9x100

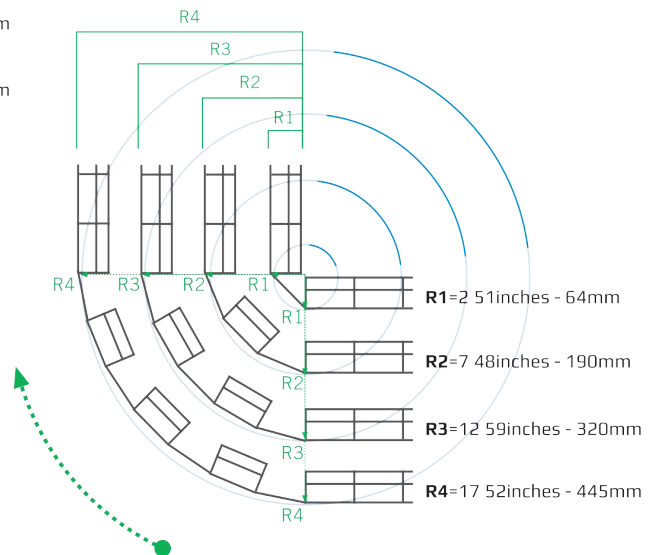
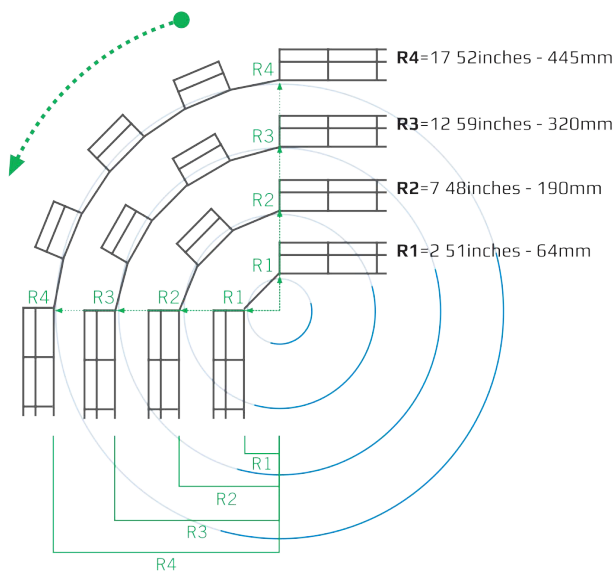

Video disponible

CAMBIOS DE NIVEL

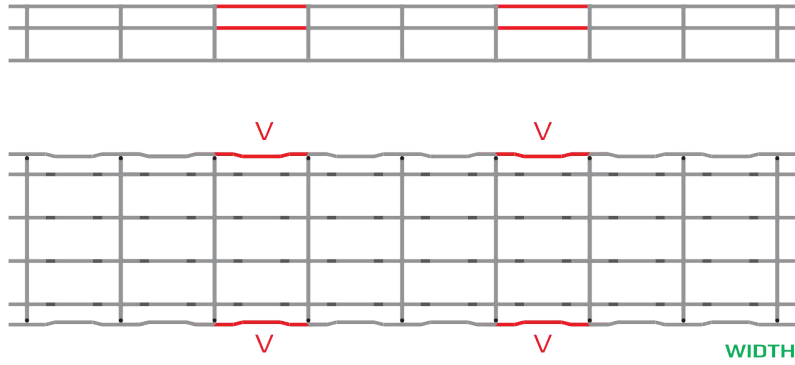

You Tube

Video disponible

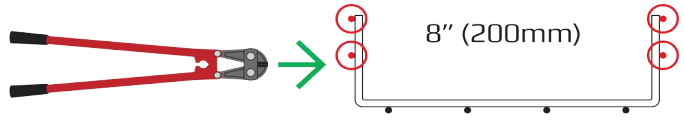

SECTION - V

V=Number of rows to cut

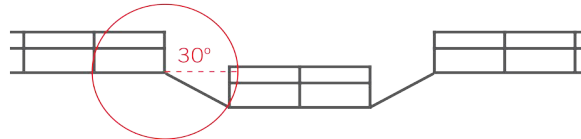
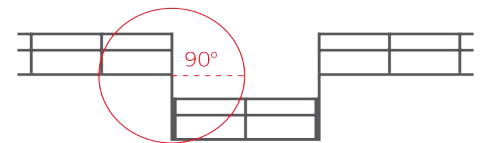
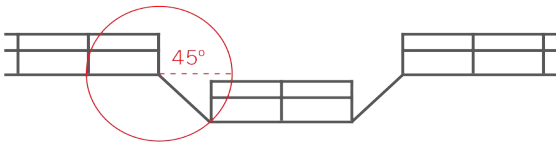

BASORFIL GIVES YOU MANY POSSIBILITIES

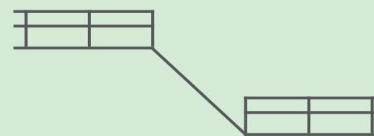
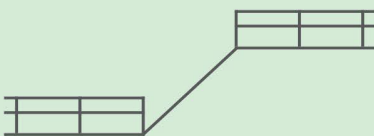
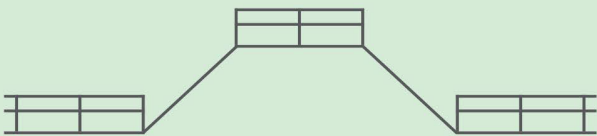

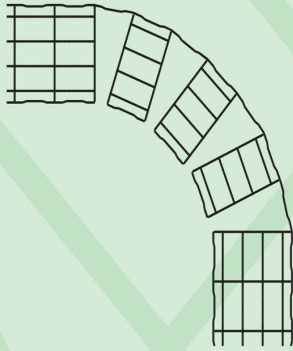

LARGE RADIUS HORIZONTAL BENDS

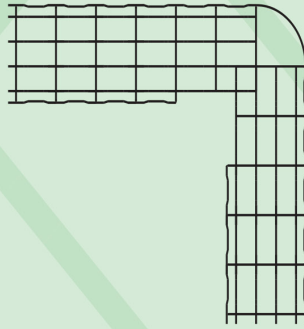

SMALL RADIUS HORIZONTAL BENDS

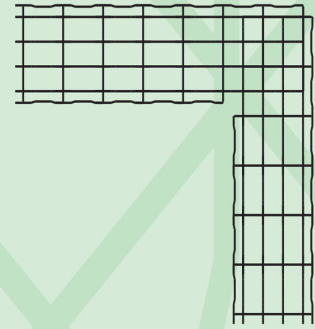

VERTICAL BENDS

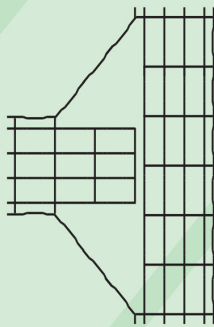

REDUCING SIZE

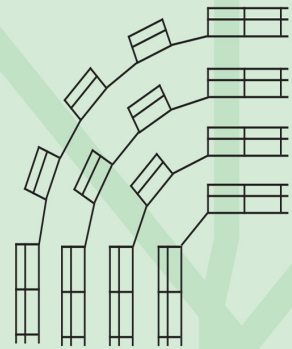
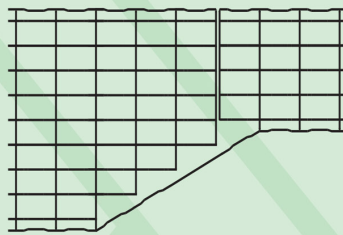

VERTICAL BENDS

3E Basor
CABLE TRAY SPECIALIST



Visita nuestro canal [youtube.com/user/basorelectric](https://www.youtube.com/user/basorelectric)